

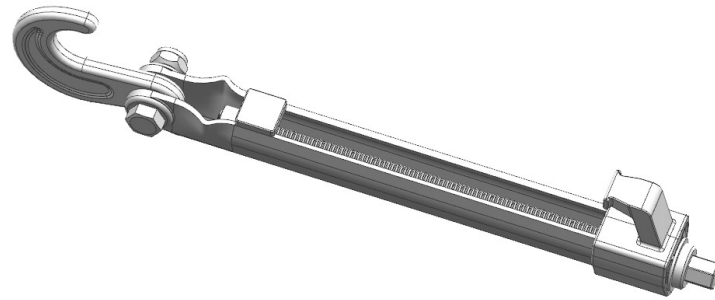

Speed lashing

Speedlash - with HMPE claw



Dimensions (mm):

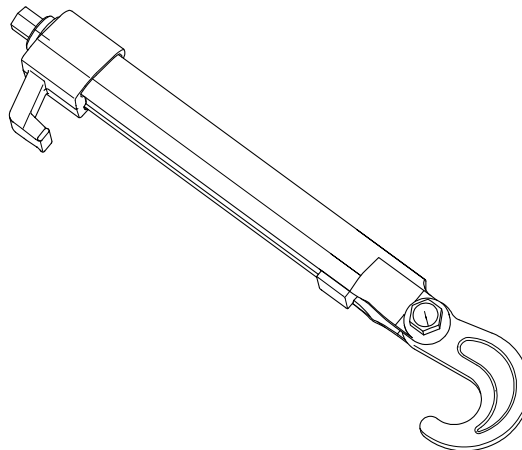
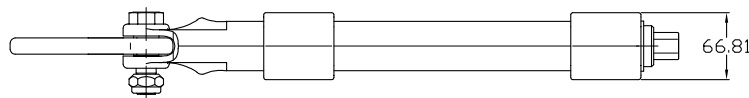
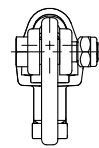
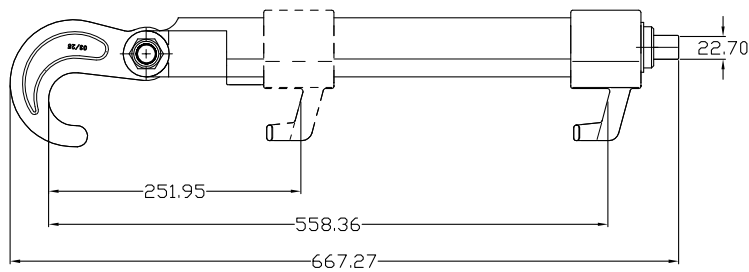
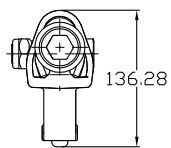
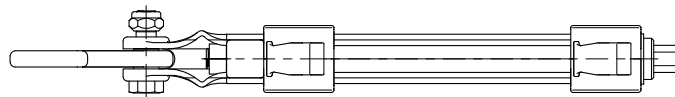

- Breaking load tension : 200 kN
- Material : steel
- Finish : hot dip galvanized
- Packing & markings : as per customer request
- Weight : 7.1 kg / piece

(Important note: Measures and weights without engagement. We reserve the right to change technical details.)