

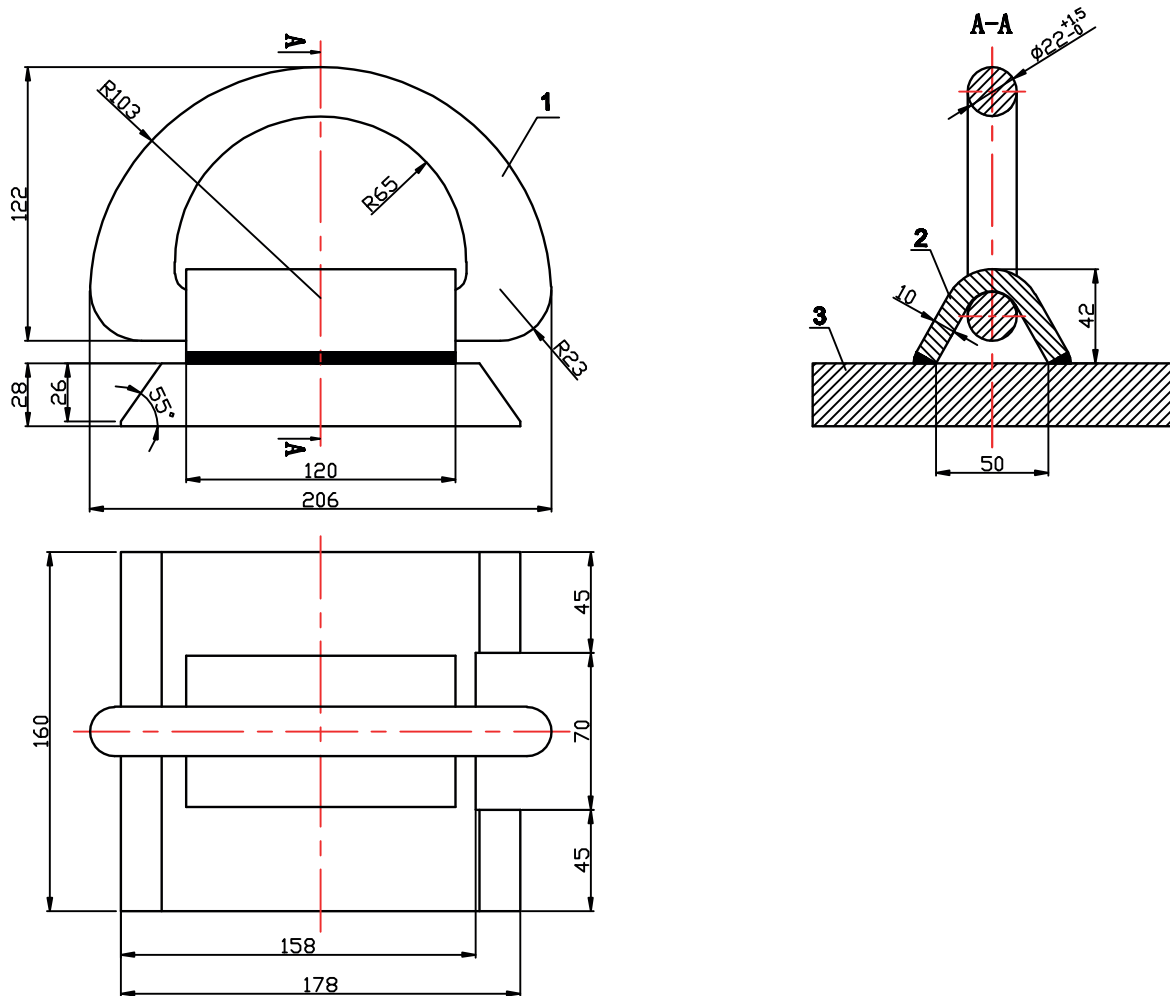

Weld-on D-rings

Dovetail D-ring MBL 36T 55°



- Material : 1) 1x D-Ring: 40Cr, forging
2) 1x Strap: Q355B T10
3) 1x Plate: Q355B T28
- Finish : painted - Shop Primer

	Save Working Load SWL	Proof Load PL	Breaking Load BL	Weight kg
Tension (kN)	180	225	360	6.8

(Important note: Measures and weights without engagement. We reserve the right to change technical details.)